

Makers Market

architecture through reuse
of construction and fashion

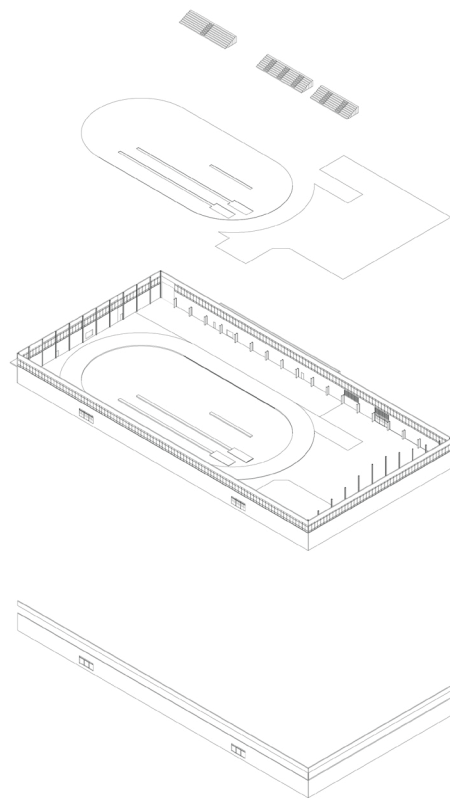

reuse

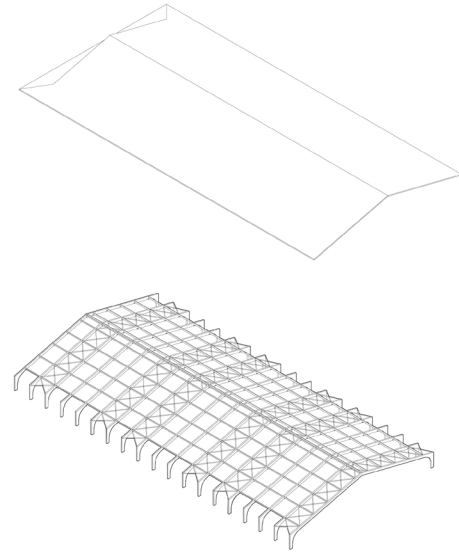

original building:
French Fieldhouse

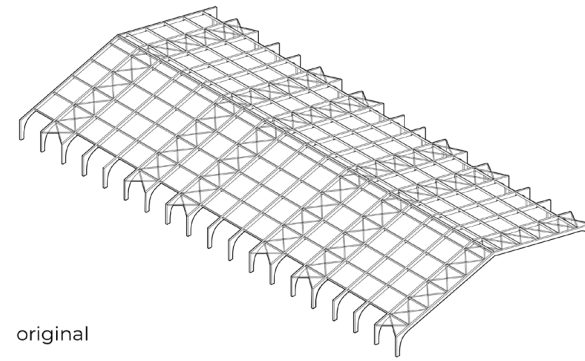

original

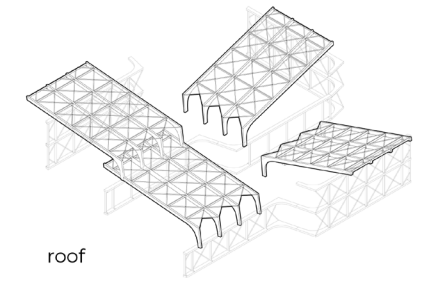
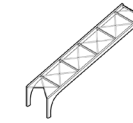

roof

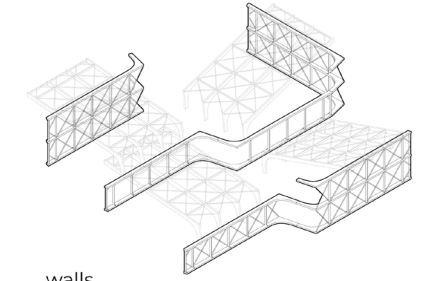

walls

project proposal:
reuse of structure

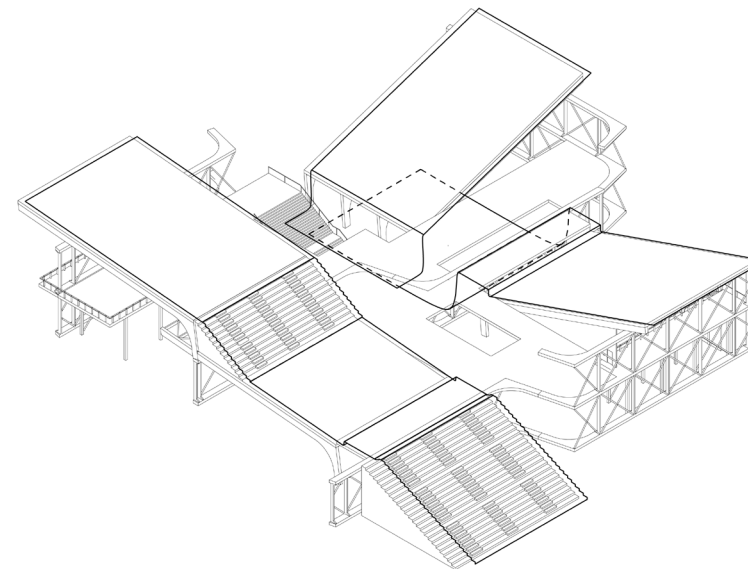

project proposal:
reuse of astroturf

sections

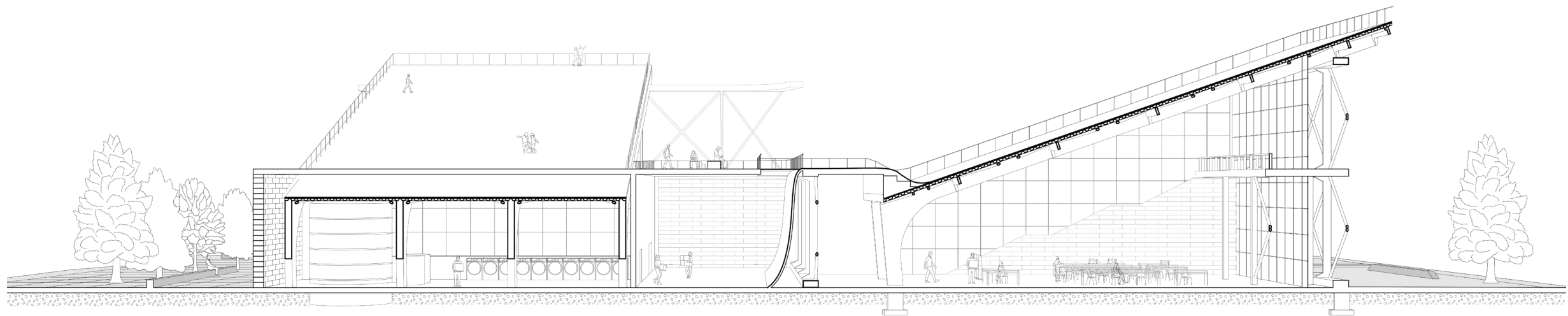
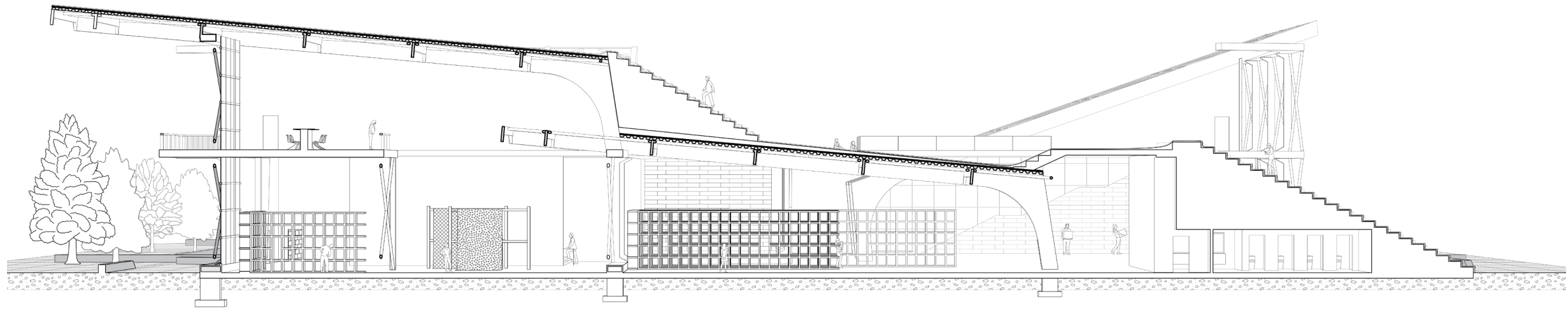

plans

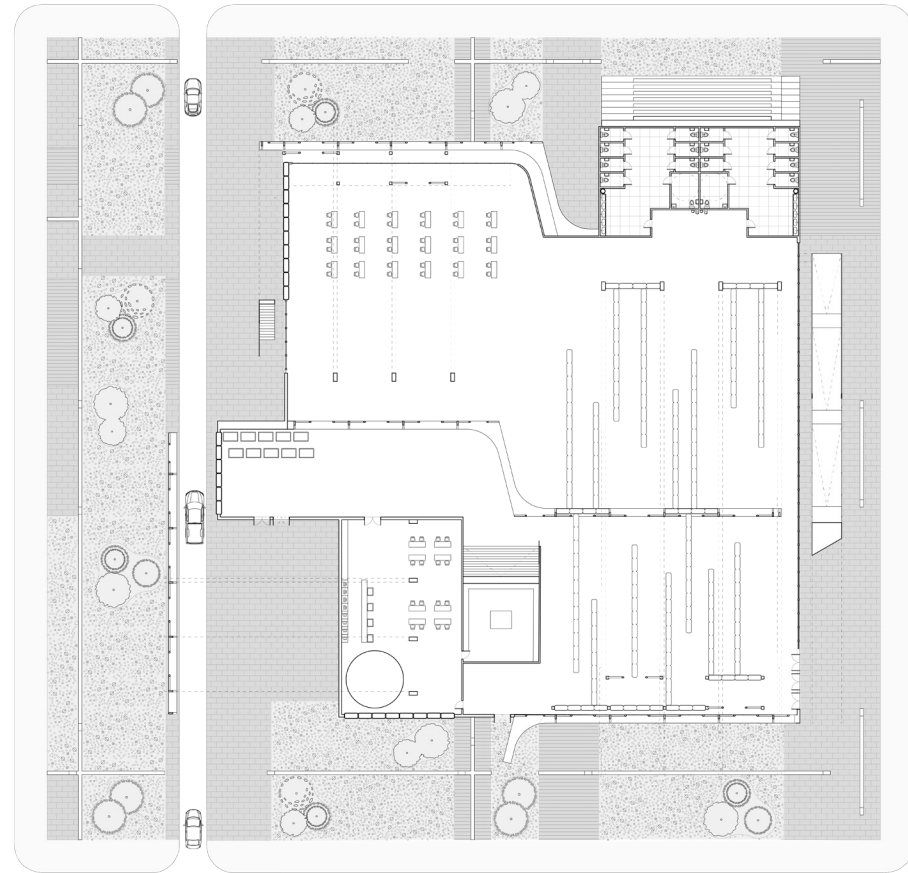

GROUND FLOOR PLAN

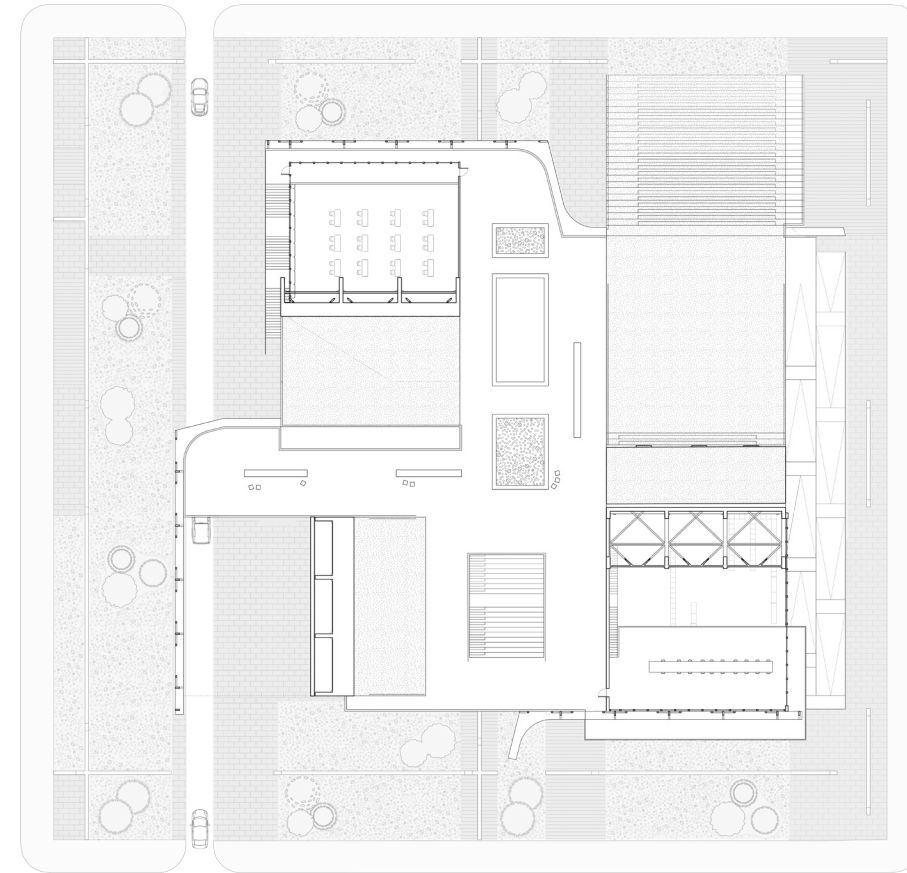

SECOND FLOOR PLAN

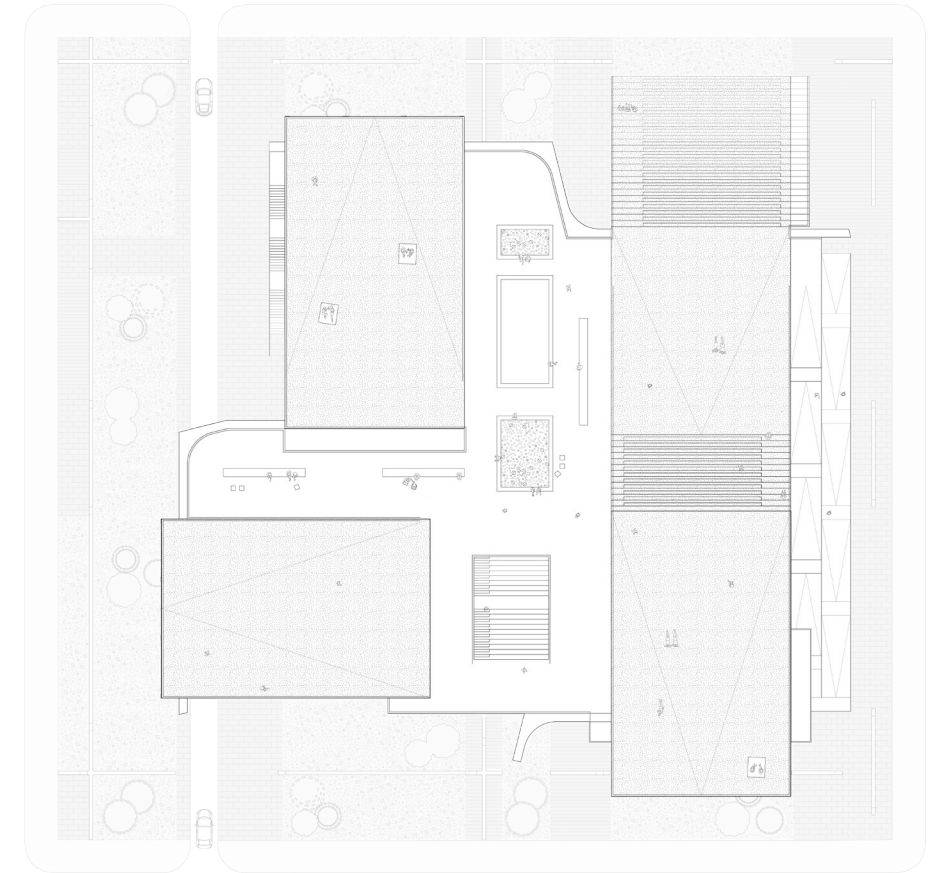

ROOF PLAN

market and park

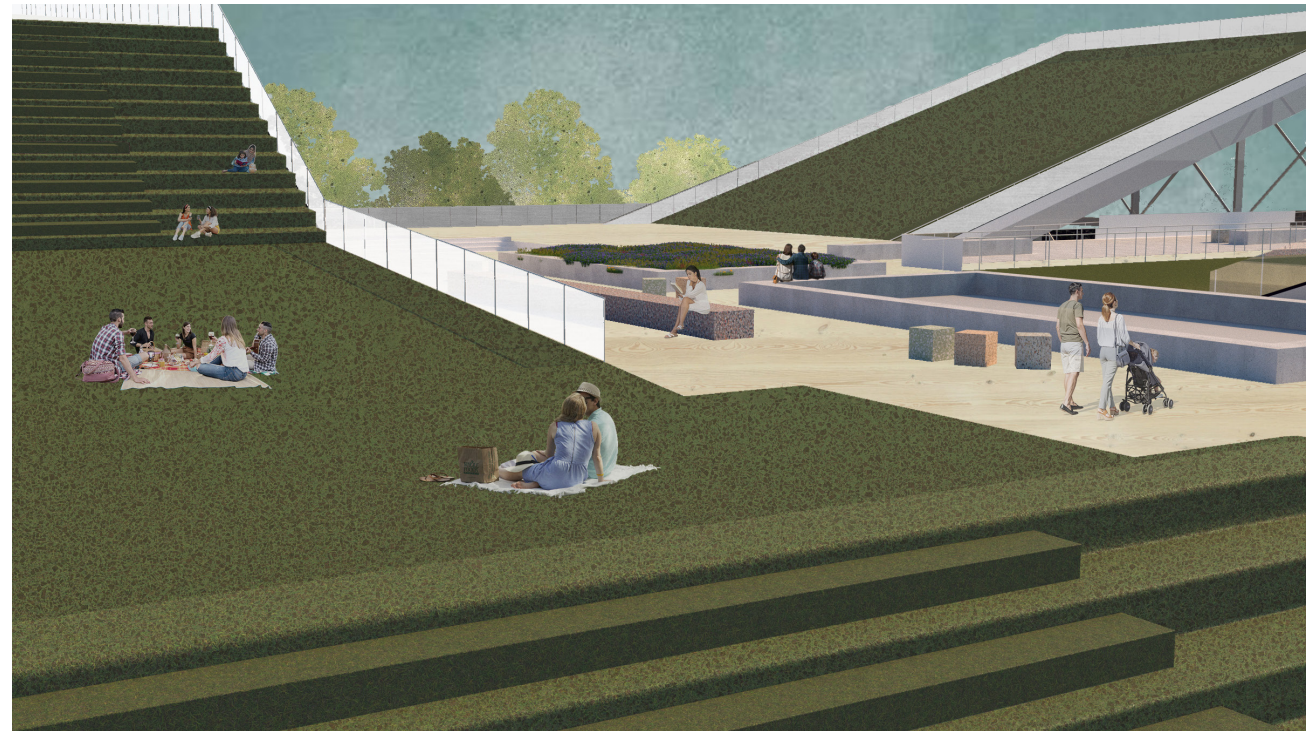
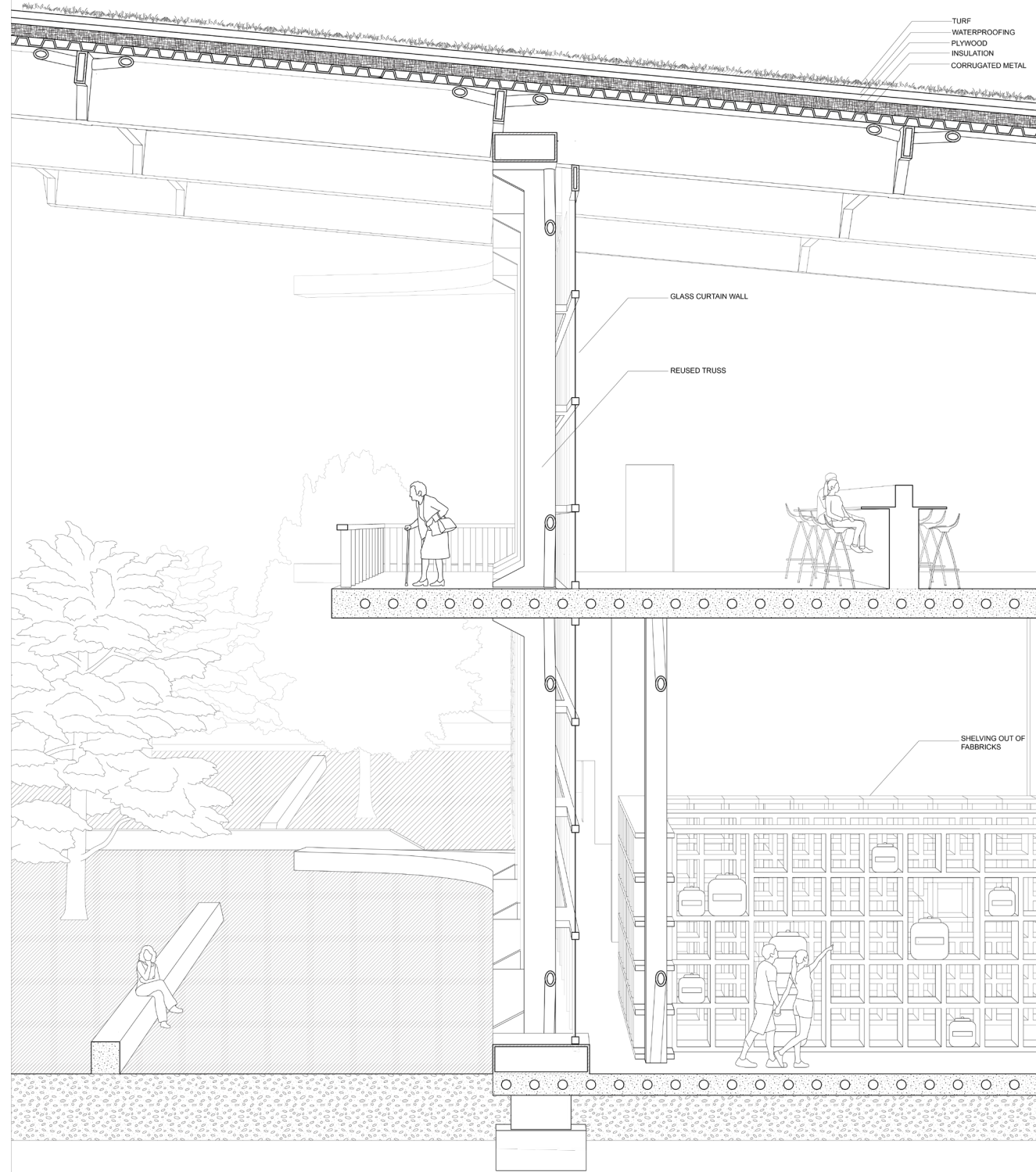

Two public amenities for the project proposal are the market space and occupiable roof.

fabric and construction

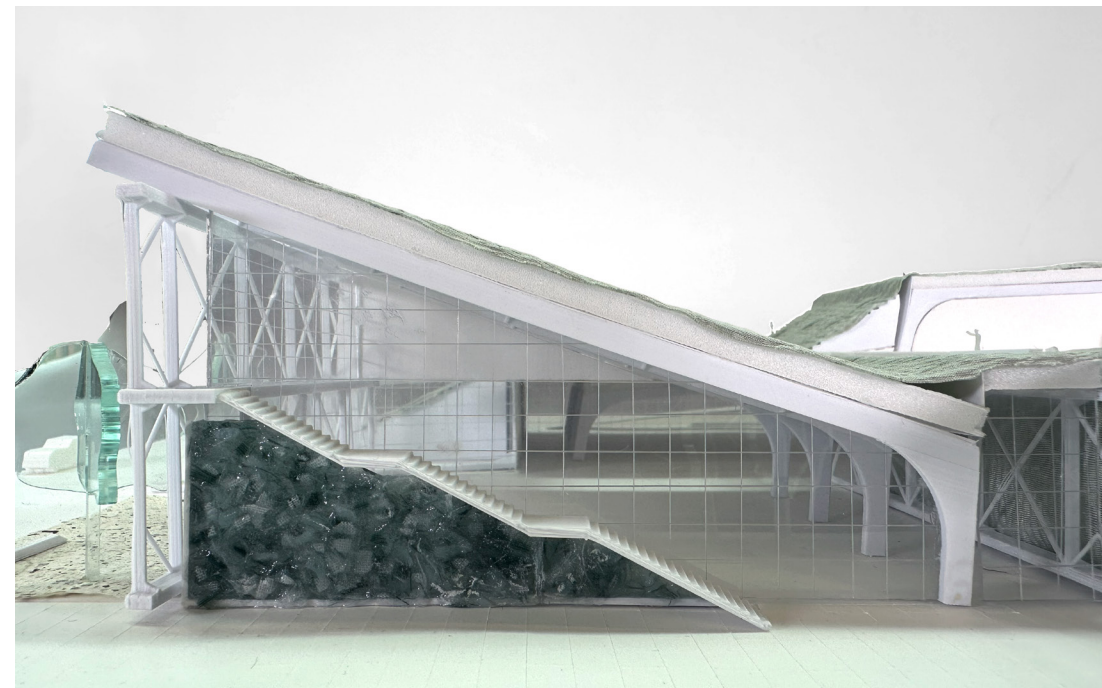

Fabric reuse is proposed to be a part of the construction of the project. Bricks made of recycled fabric create walls the showcase an innovative use for recycled textiles materials and can change the space through changes in opacity and color.

maker space

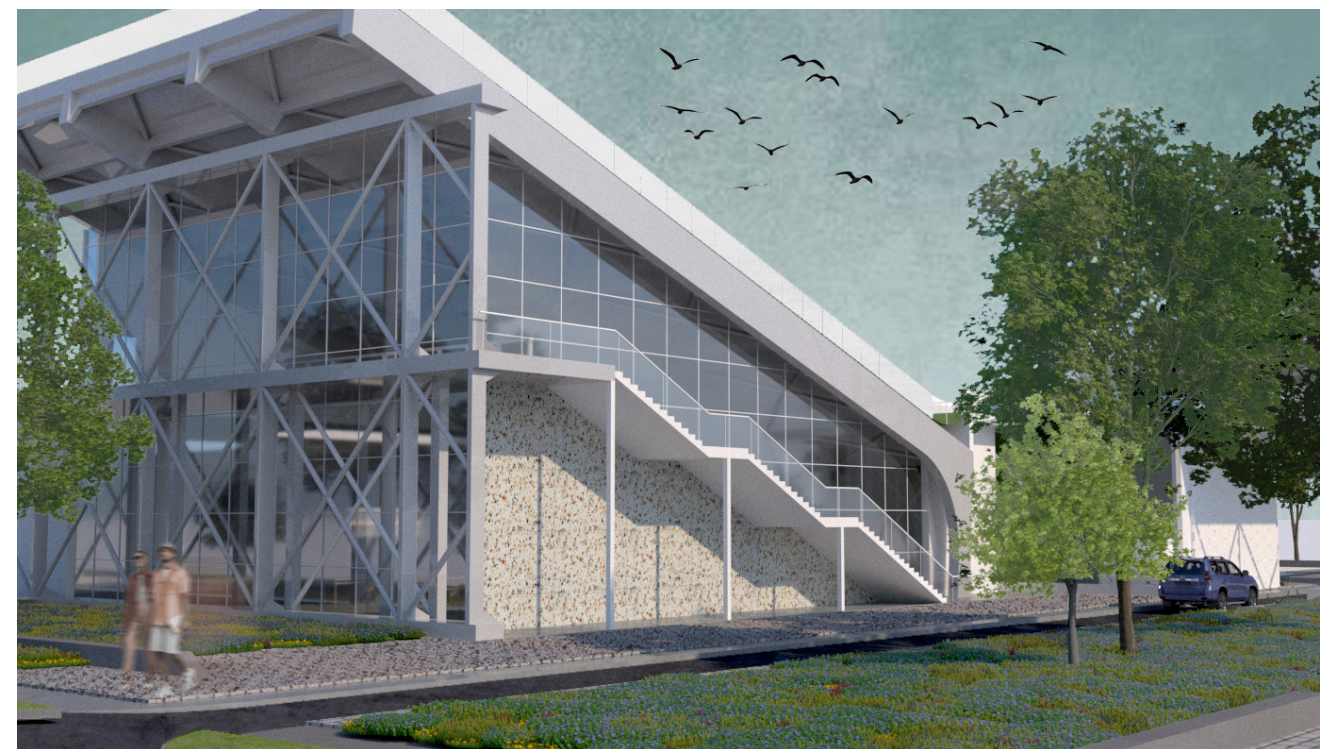
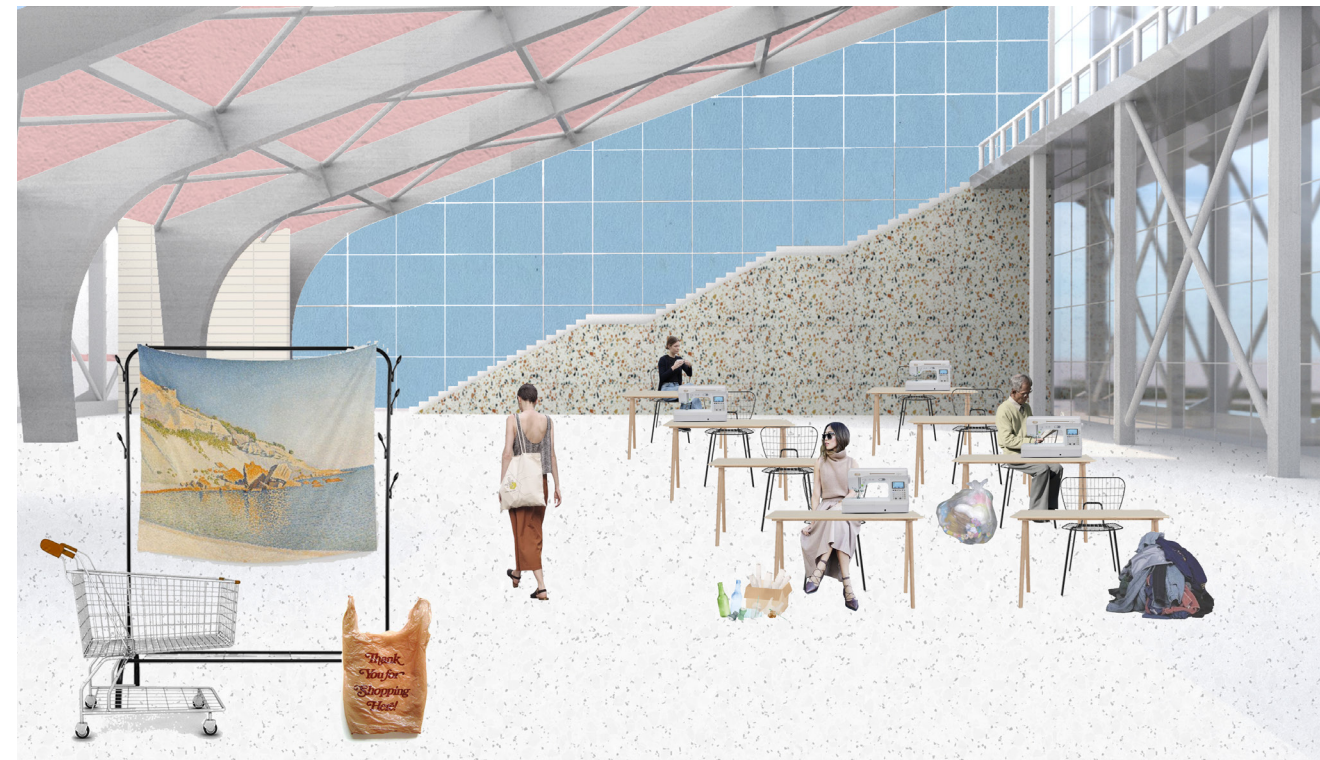
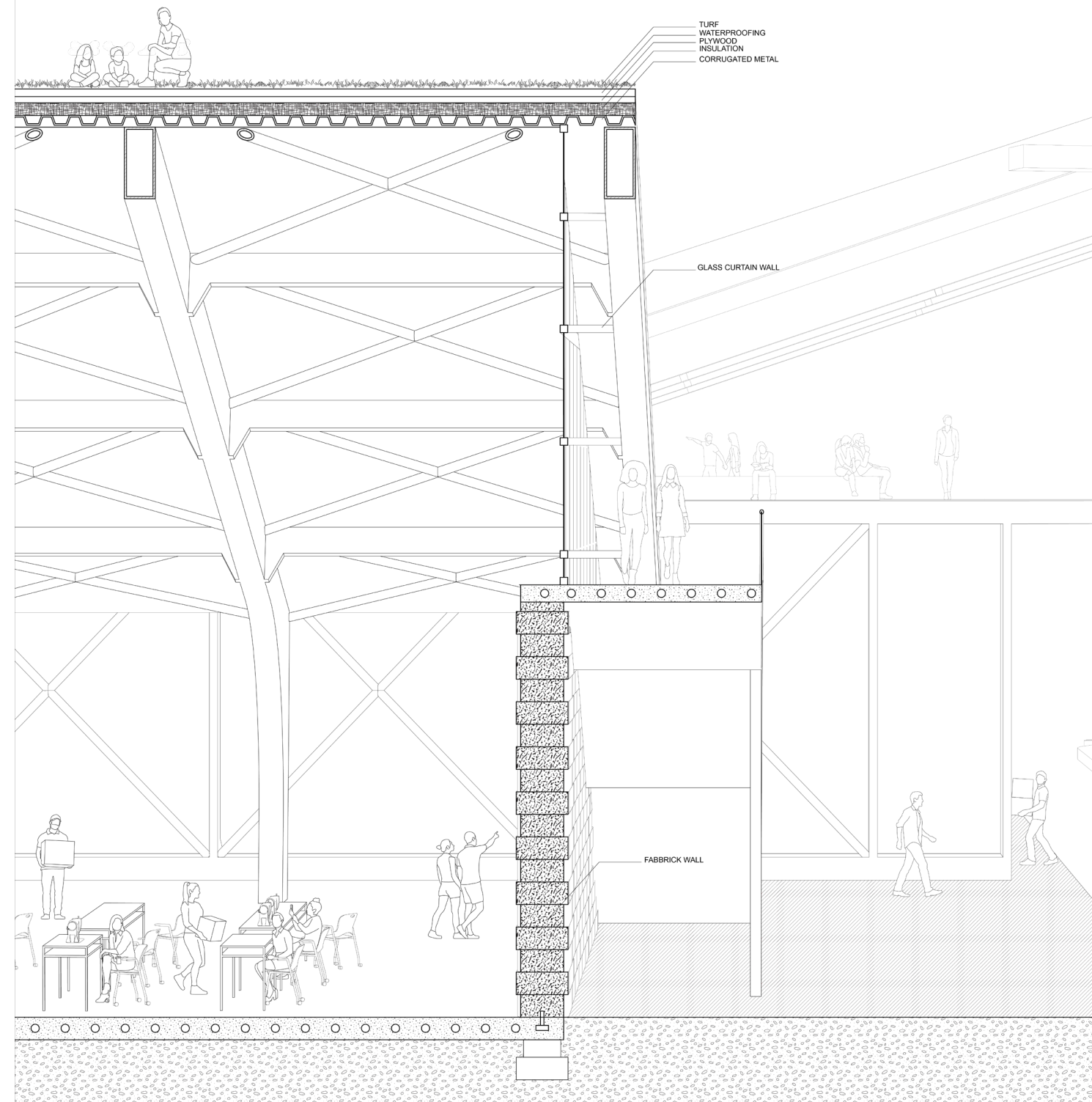

section model



model

